

DANTE

CERTIFICATION PROGRAM

LEVEL 1

THE DANTE CERTIFICATION PROGRAM

Training program from Audinate



Official certification lets your customers know that you have the knowledge and skills to implement Dante networks



Ensures a consistent set of methods and knowledge



THE DANTE CERTIFICATION PROGRAM

With Dante Certification,
you receive:

- Use of the Level 1 and Level 2 “Dante Certified” logos
- A certificate of completion for each level passed.
- Optional listing in directory of Dante Certified professionals



THE DANTE CERTIFICATION PROGRAM

Level 1: Introduction to Dante

- In-person and online delivery
- Background
- Basic signal routing with Dante Controller
- Setting up Dante in simple systems (approximately 6 devices, 1 switch)
- Recording with Dante Virtual Soundcard



THE DANTE CERTIFICATION PROGRAM

Level 2: Intermediate Dante Concepts

- Delivered in-person
- Larger systems (approx. 12 devices)
- Clocking options
- Understanding unicast & multicast
- Latency
- Redundancy
- Dante Virtual Soundcard and Dante Via in depth



THE DANTE CERTIFICATION PROGRAM

Required steps:

- Level 1: Pass Level 1 **online** exam
- Level 2: Pass Level 2 **online** exam
PLUS “hands on” exam at event



INTRODUCTION TO DANTE

DANTE CERTIFICATION PROGRAM
LEVEL 1

ABOUT AUDINATE



Headquartered in
Sydney, Australia

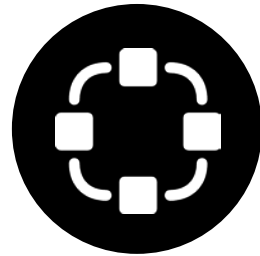

Network
engineers first



Develop Dante as
100%
interoperable
solution
for all audio
manufacturers

WHAT WE MAKE

Dante technology
(all of it)

Hardware modules

Development tools

Software products:

- Dante Controller
- Dante Virtual Soundcard
- Dante Via

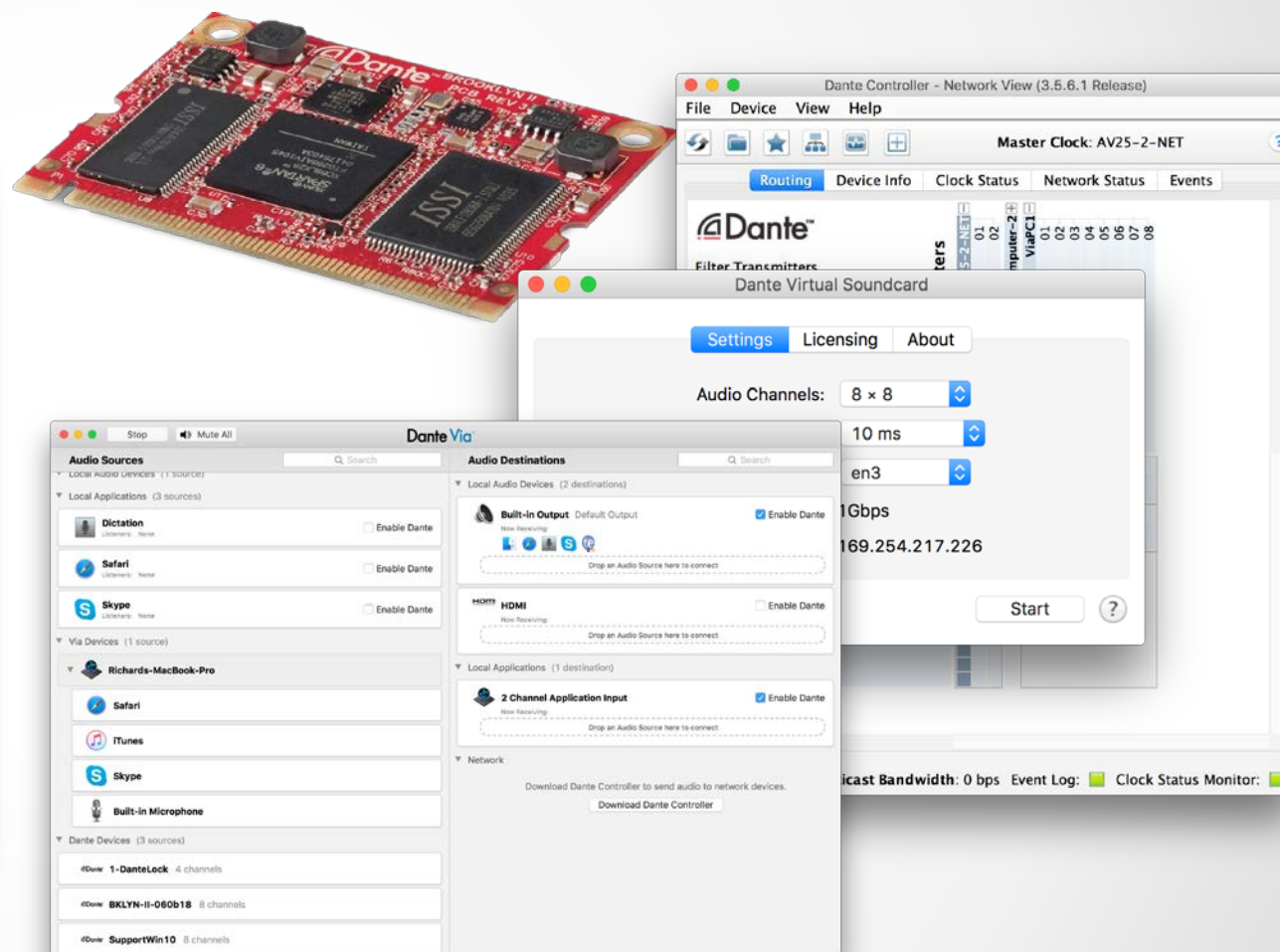



LEVEL 1 TOPICS

Digital audio
basics

IP
networking
basics

What is
 **Dante™**

Using
 **Dante™**



DIGITAL AUDIO BASICS

LEVEL 1

DANTE CERTIFICATION PROGRAM

ANALOG TO DIGITAL CONVERSION

Analog signal is sampled at constant intervals



Yields a stream of values in time



Pulse Code Modulation (PCM)

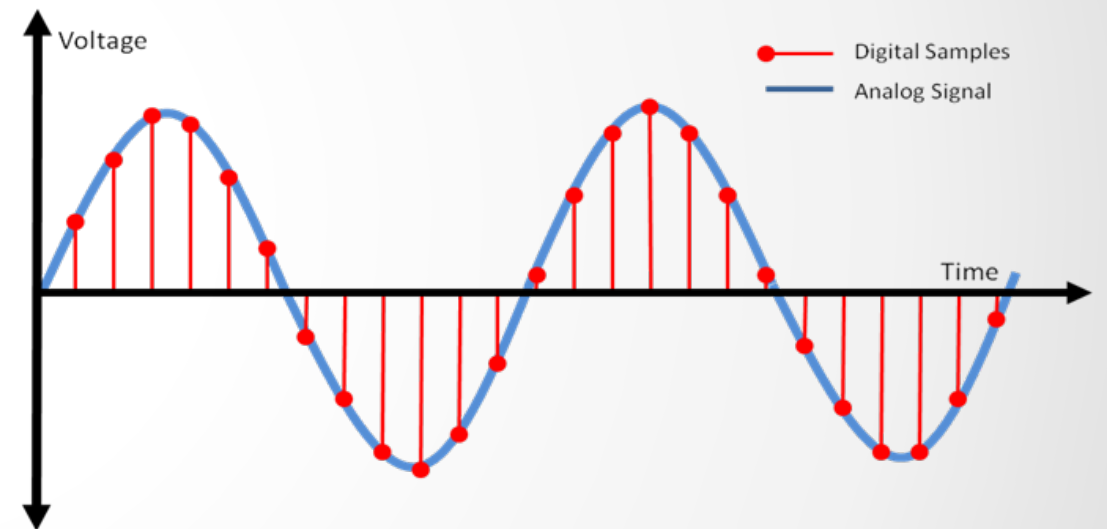

SAMPLE RATE

Interval at which samples are taken



Nyquist Theorem:
Samples must be taken at
least 2x maximum audio
frequency

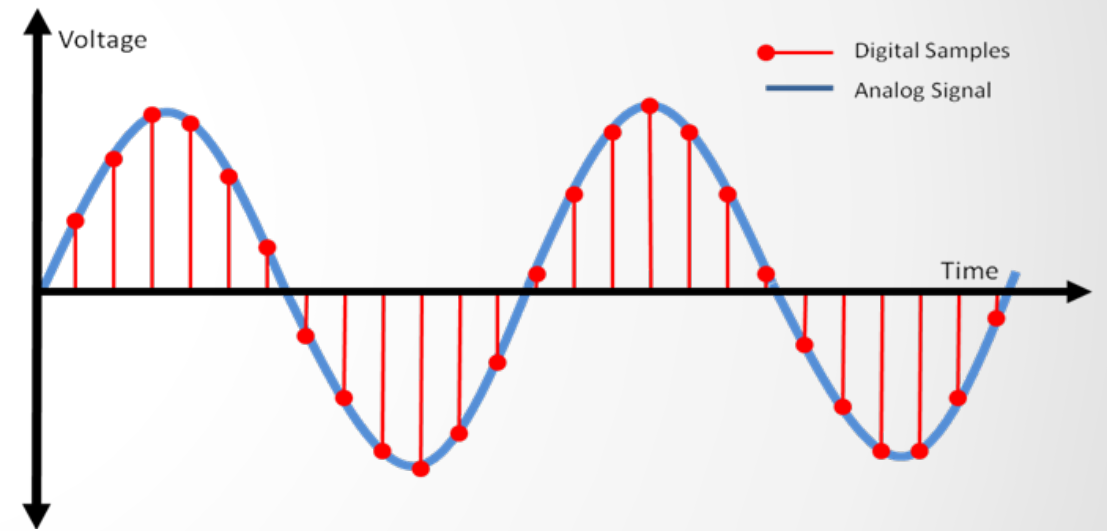

BIT DEPTH

How many bits are used to represent amplitude



More bits -> more accuracy

CDs: 16 bits

Pro: 24 bits

Number of Bits	Number of Values
1	2
2	4
4	16
8	256
16	65536
24	16777216
32	4294967296

COMBINING SAMPLE RATE & BIT DEPTH

More of each -> greater fidelity

- Increased bandwidth usage

- Greater sample rates -> fewer I/O channels

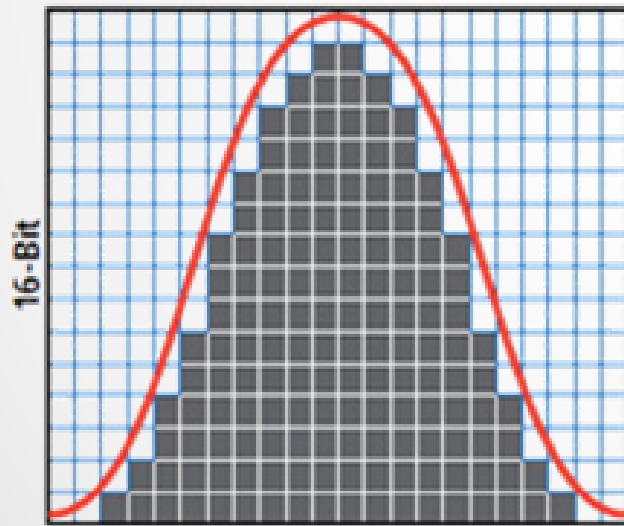

44kHz

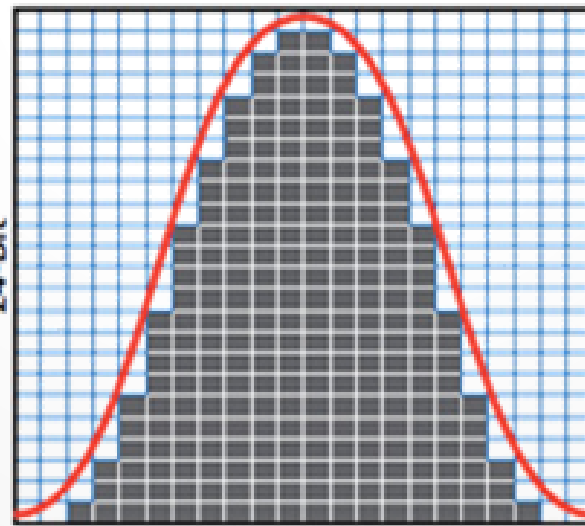

44kHz

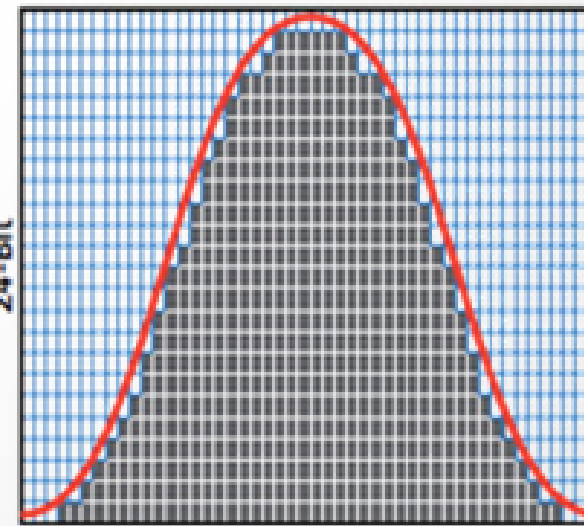

96kHz

BANDWIDTH USAGE

PCM Audio Bandwidth = (Sample rate) x (Bit depth) x (No. of channels)

●
Example: 64 channels of PCM audio at 48kHz/24-bit =
 $48,000 \times 24 \times 64 = \underline{74 \text{ mbits/sec}}$

●
With network overhead, 64 channels \approx 96mbps

●
Less than 10% of a gigabit link

WORD CLOCK

The clock that determines where in the data an audio sample begins



Must be consistent for all devices in a digital system so that data is read the same way



Single Clock Master for multi-device systems



JITTER

Distortion caused by inconsistent word clock in playout

- Exists in all Digital Audio Systems

- AES3, MADI, ADAT, S/PDIF

- Expensive to solve in older systems

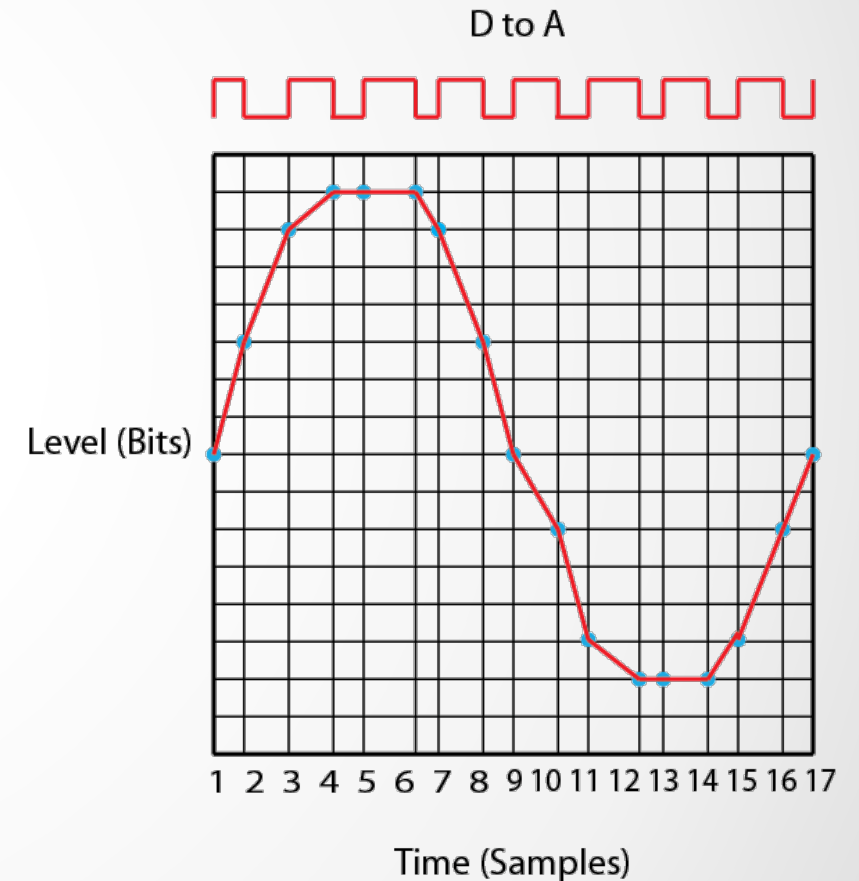

LATENCY

Audio signal delay in a system

- Transport and processing

- Mainly a problem when we hear delayed and un-delayed signal simultaneously

- Problem for legacy networking systems (VoIP)

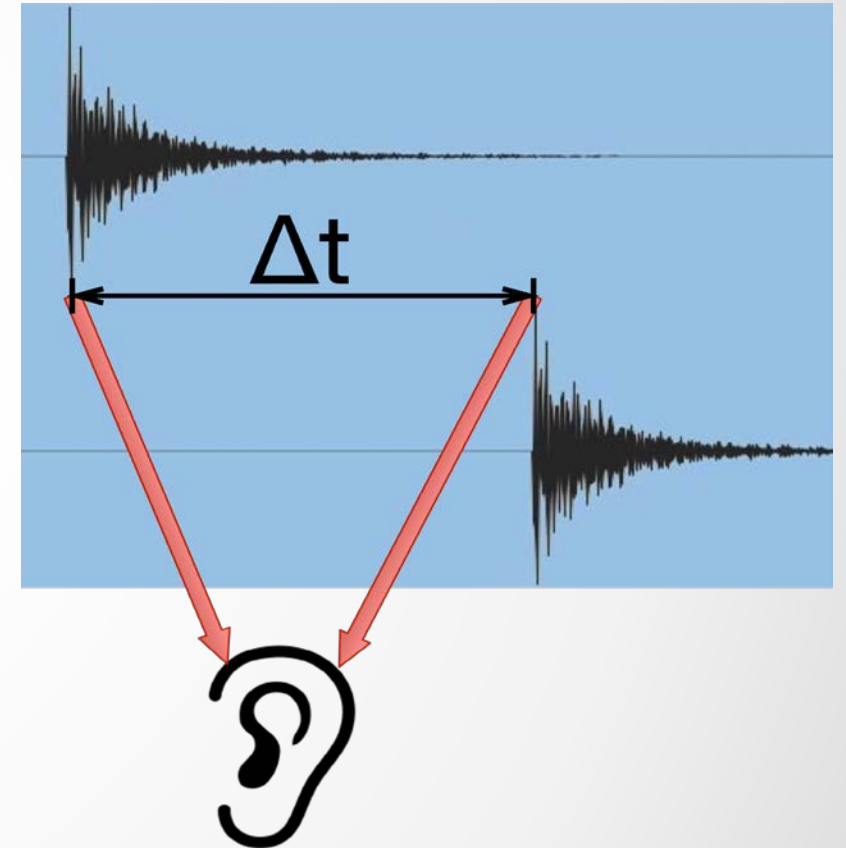

SUMMARY

Digital audio works by playing out or recording samples

Bit depth describes amplitude resolution

Sample rate determines maximum analog frequency



Word clock must be consistent and correctly sync'd



Digital audio produces data that can be transported like any other – *time* is the key that Dante provides



IP NETWORKING

BASICS

DANTE CERTIFICATION PROGRAM
LEVEL 1



HOW MUCH NETWORKING DO I NEED TO KNOW?

NOT VERY MUCH
(USUALLY)

PHYSICAL SIDE OF NETWORKING

Modern small networks are made of 3 things:

Things that get connected

Switches: provide a central bridge for connections

Cables: connect them together



WHAT KIND OF CABLE FOR DANTE?

Same as for any regular
computer network

- Gigabit rated:
CAT5E
CAT6

- 100 meters max per run



WHAT ABOUT WI-FI?



Wi-Fi is another way to connect to IP networks

- Less reliable than wired Ethernet

- Not compatible with Dante audio

- OK for Dante Controller only

WHAT ABOUT FIBER?

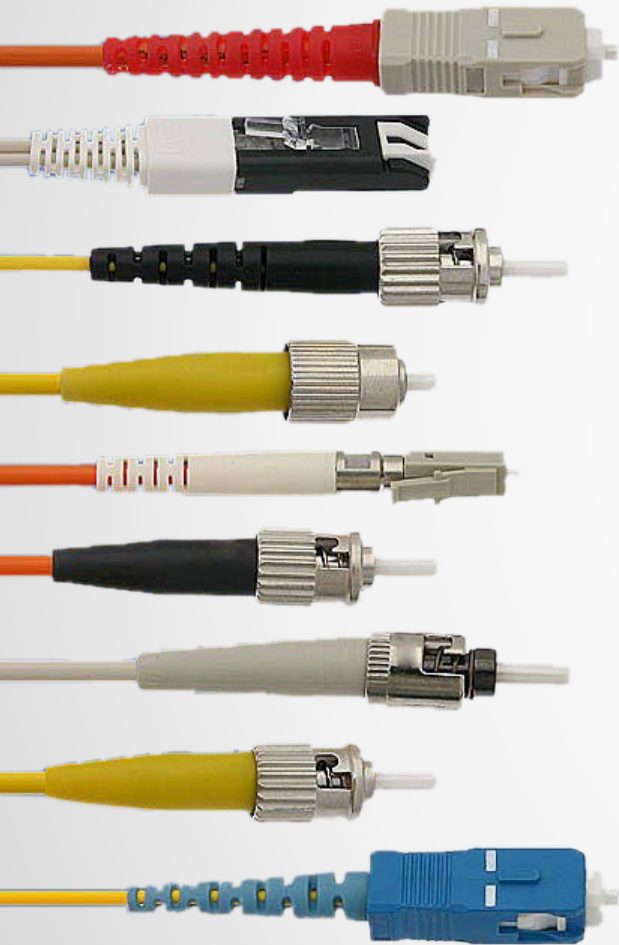

Just another
way to do
Ethernet

Much
greater
distances if
needed

Requires
switches with
SFP

SWITCHES

Switches connect devices on a common network

- Available small (5 ports) up to large (48 ports)

- Switches support all ports going full speed all the time

- Use gigabit (or faster) switches!

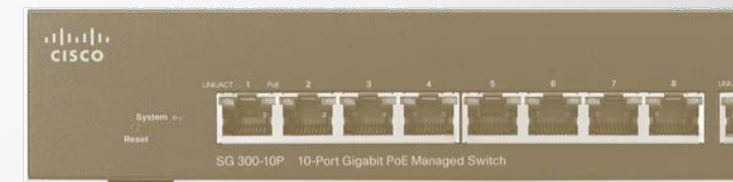

SWITCHES – UNMANAGED & MANAGED

Unmanaged switches – plug ‘n play, limited



Managed switches – many, many options, tests and adjustments



Dante works with either type



Managed switches useful in “mixed” (e.g., audio + other data) or heavily loaded networks



Unmanaged switches good in small dedicated audio networks



THEN YOU DON'T NEED A MANAGED SWITCH

If you use only one switch to connect your Dante devices...

And you are only using the network for Dante audio...

EEE SWITCHES

One special note:



EEE or “Green” switches are often not good choices for real time media



The energy saving feature will shut down ports and prevent parts of Dante from working properly



Disable this feature, or use switches that do not support it



**Energy-Efficient
Ethernet**

TOPOLOGY

Daisy chain

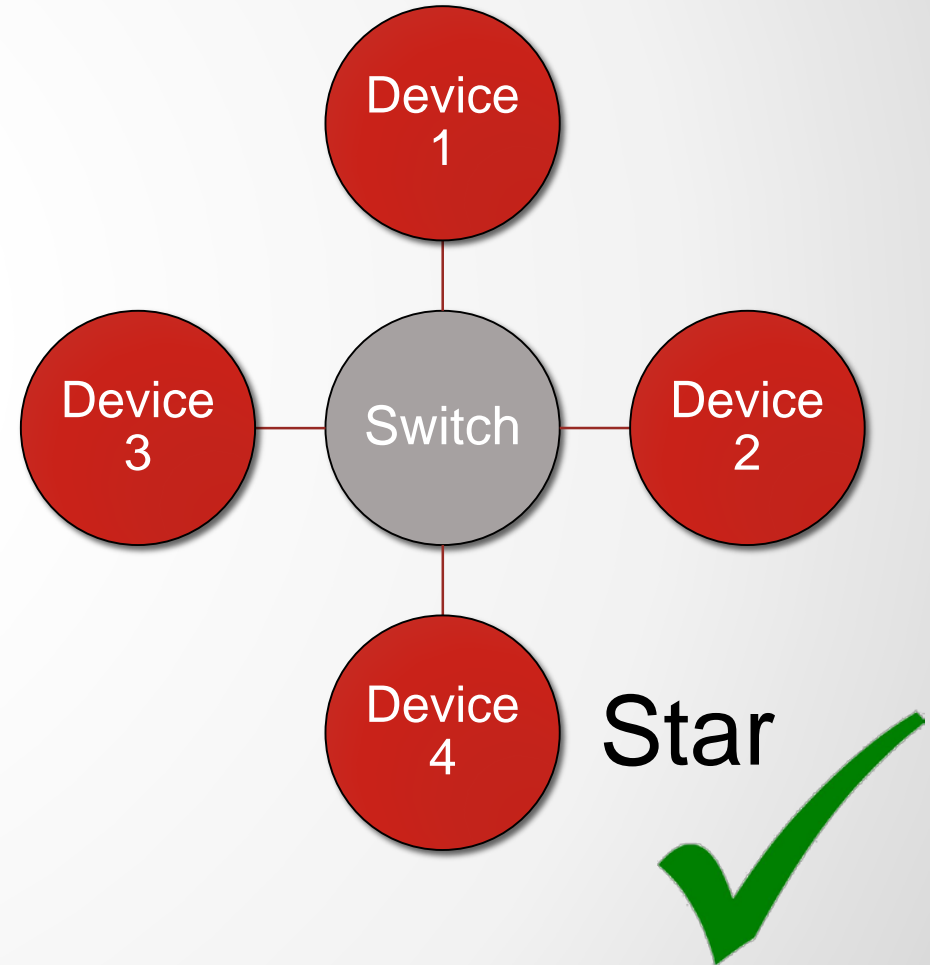
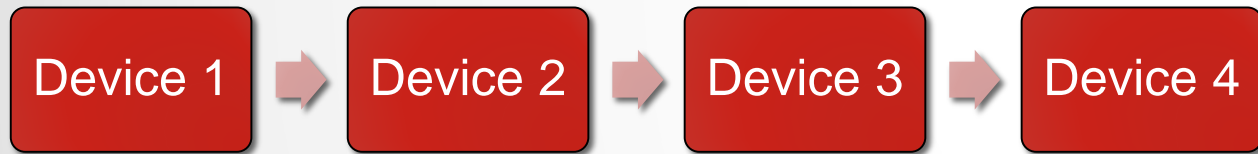

SINGLE SWITCH EXAMPLE

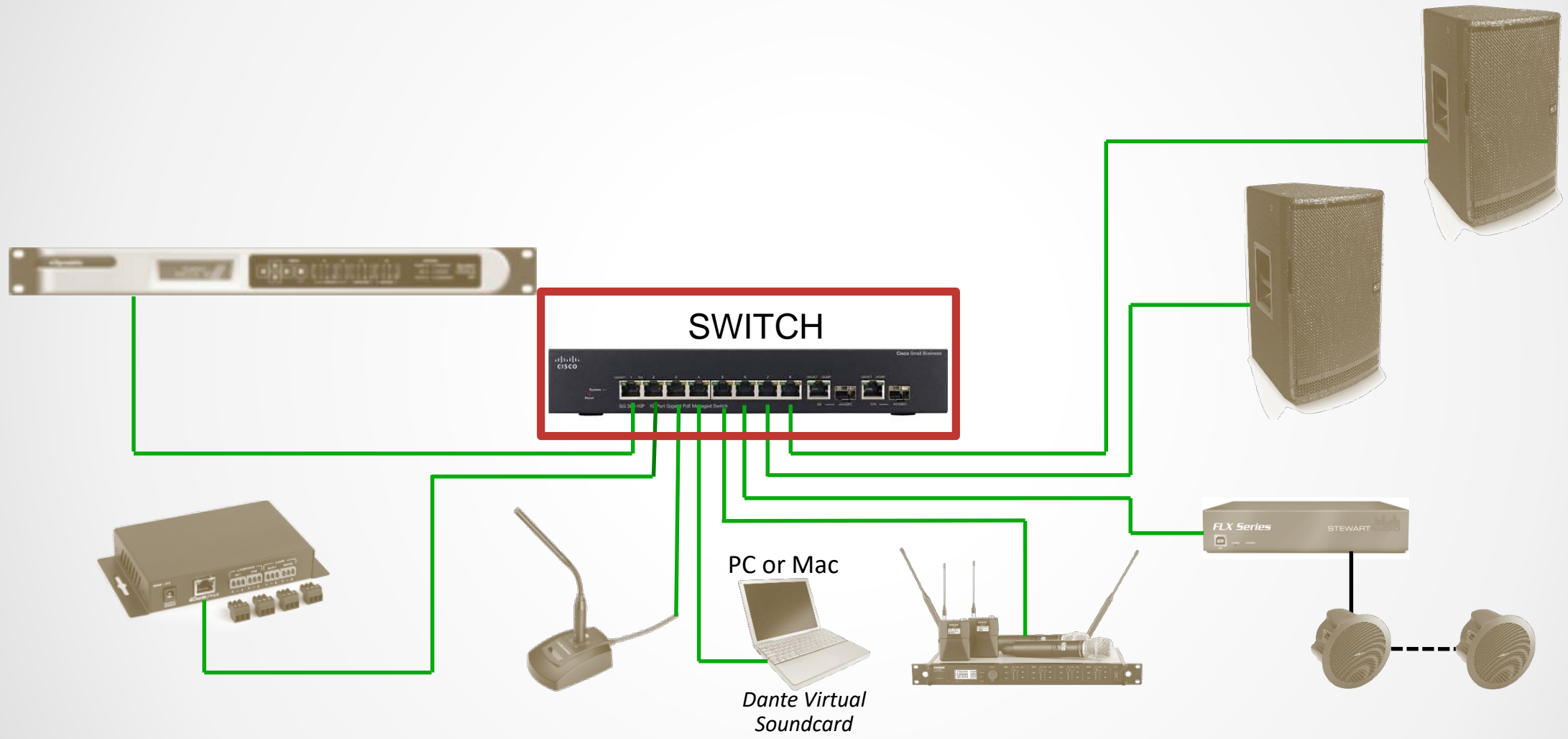



MULTIPLE STARS

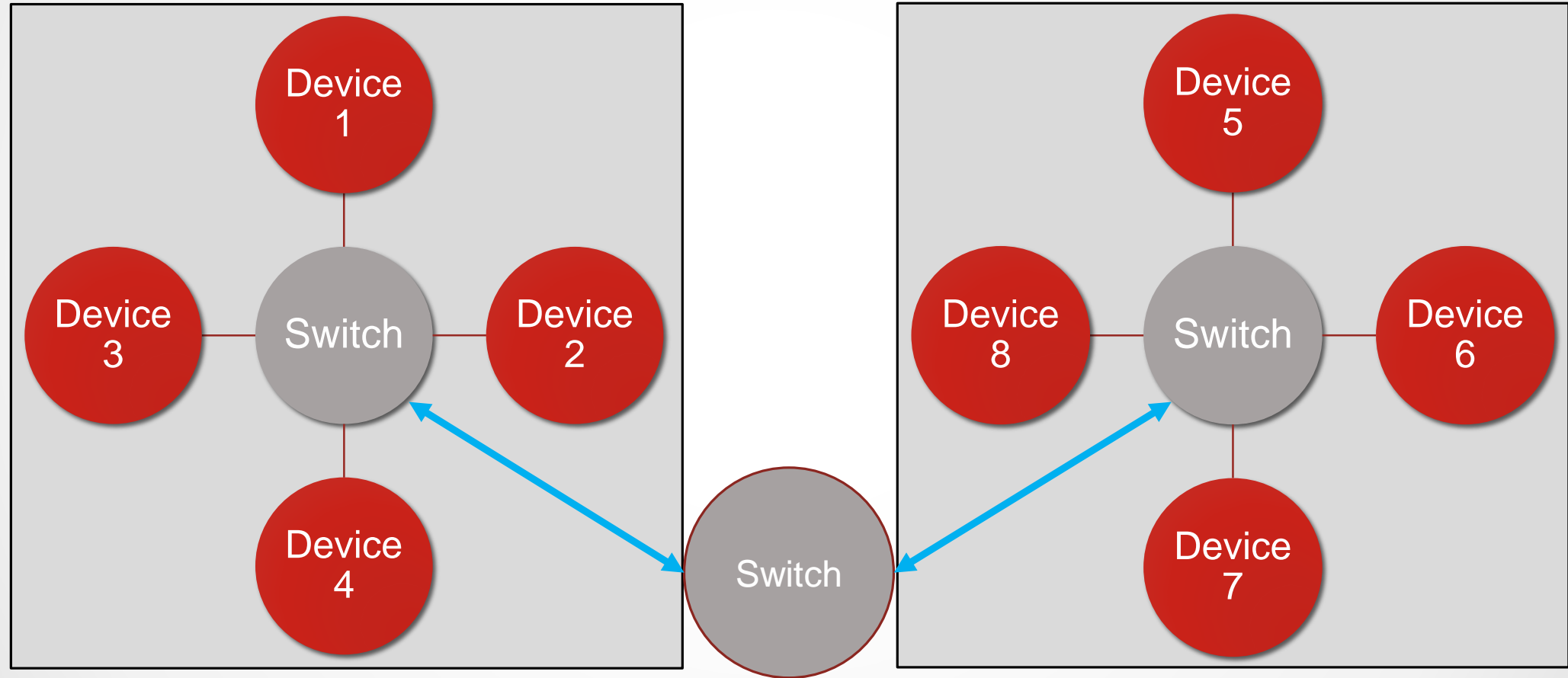

MULTIPLE STARS EXAMPLE

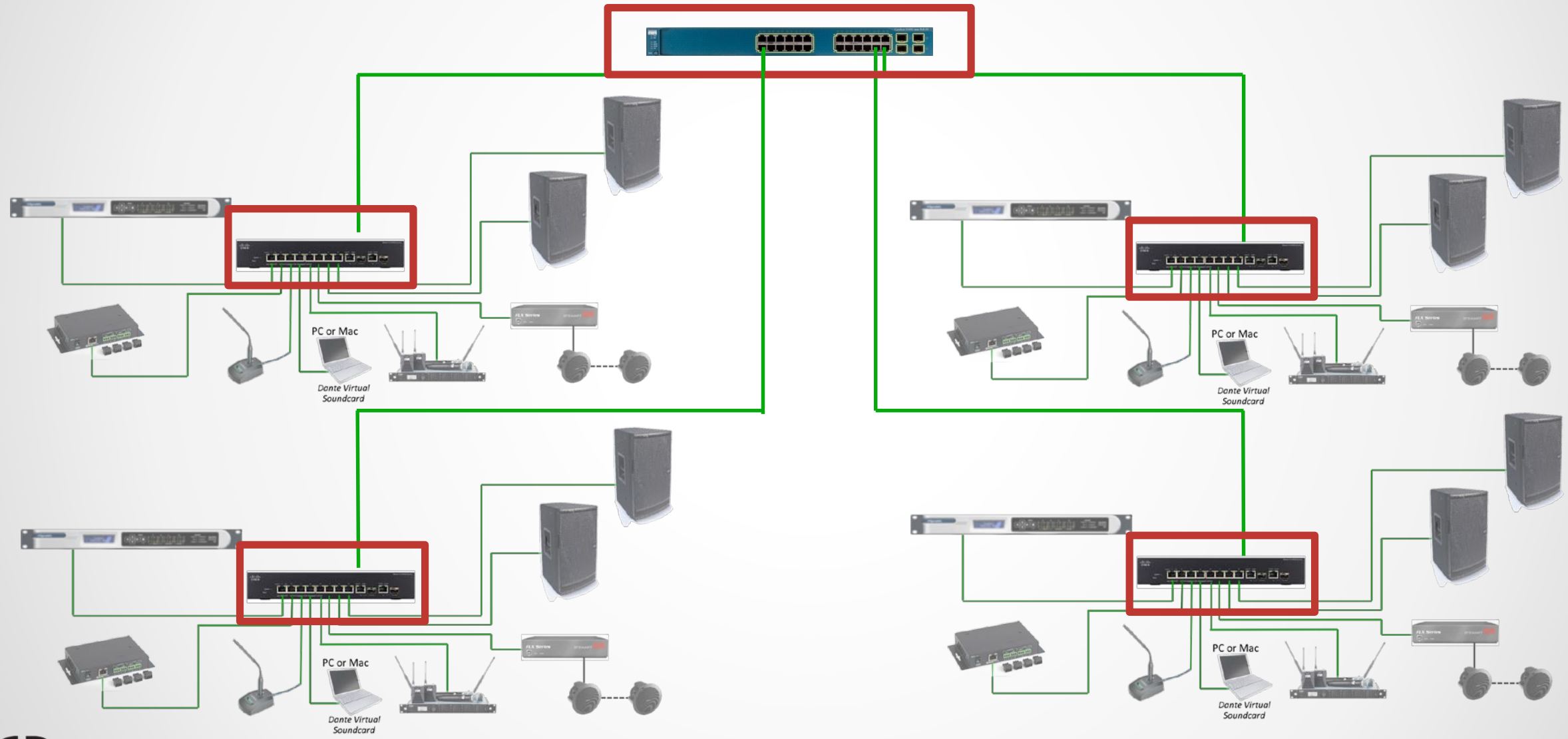



SUMMARY

- Always use gigabit switches
- Use CAT5E or CAT6 cable
- Use fiber for long runs (over 100 meters)
- Use either managed or unmanaged switches for smaller networks
- Dante-only networks with one switch do not require management features, and may safely use unmanaged switches.
- Use a "Star" topology to minimize switch hops
- Avoid or disable "green" or EEE features

LOGICAL SIDE OF NETWORKING

In analog, physical wiring showed signal paths



In networks, connections “logical” – name-to-name



Each cable carries many signals for many devices



Data delivered in packets



Network technology is neutral; no special gear needed for audio

A WORD ABOUT NETWORK LAYERS

Each layer passes data to the next

Layer 1: physical connections (e.g., cables)



Layer 2: devices represented by fixed hardware addresses (MAC)



Layer 3: devices represented by variable IP addresses

Physical (hardware & cables)

Hardware addresses

IP addresses

WHAT IS AN IP ADDRESS?

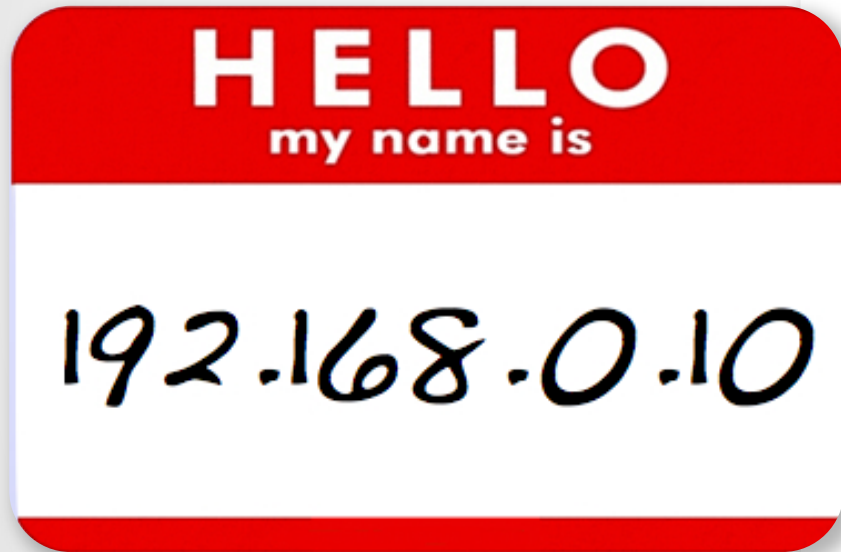

Numeric addresses associated with devices

- On a LAN, direct communication only possible between devices in the **same** IP address range

- LAN: all addresses in same range

- Dynamic (preferred) or user-assigned

- Avoid manual (static) addressing to avoid duplicates or unreachable addresses

WHAT IS A LAN?

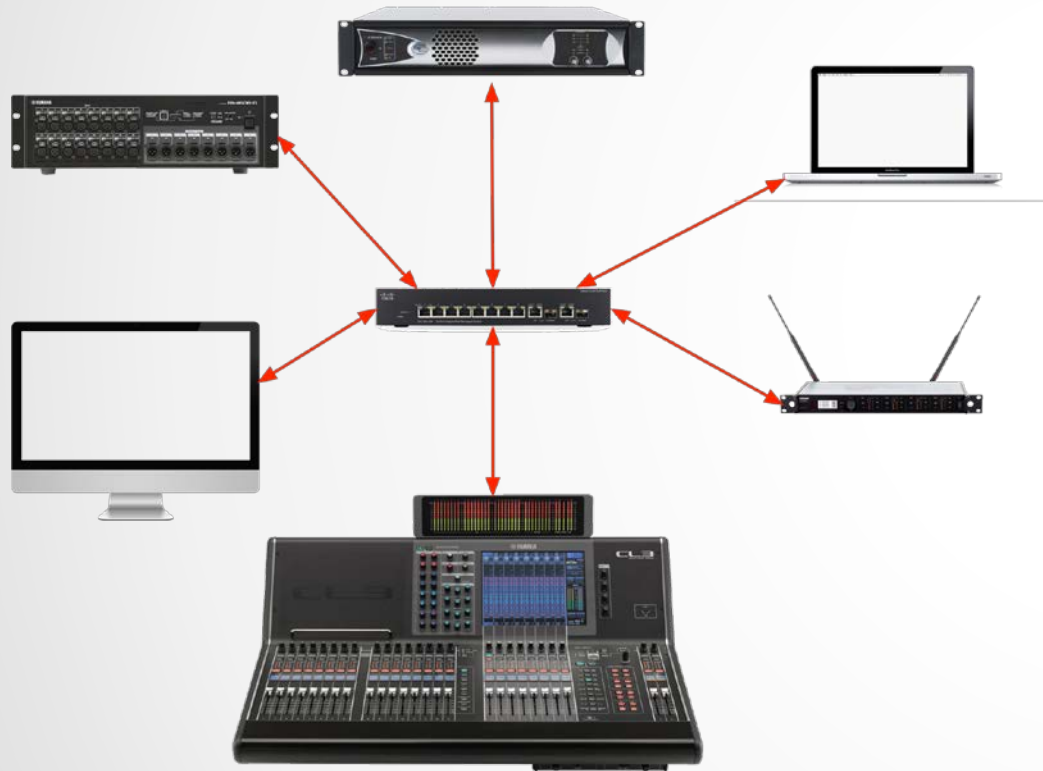

Local-area Network

- Small number of devices (<200)
- Very reliable, fast
- Shares a common IP address range
- Majority of audio networks are LANs

WHAT IS A "STAND ALONE" NETWORK?

A single LAN



Usually dedicated to one purpose



Not dependent upon external resources
(e.g., internet, servers)



Not connected to other LANs through a router



Commonly used to separate responsibilities of AV installer

AUTOMATIC ADDRESSING

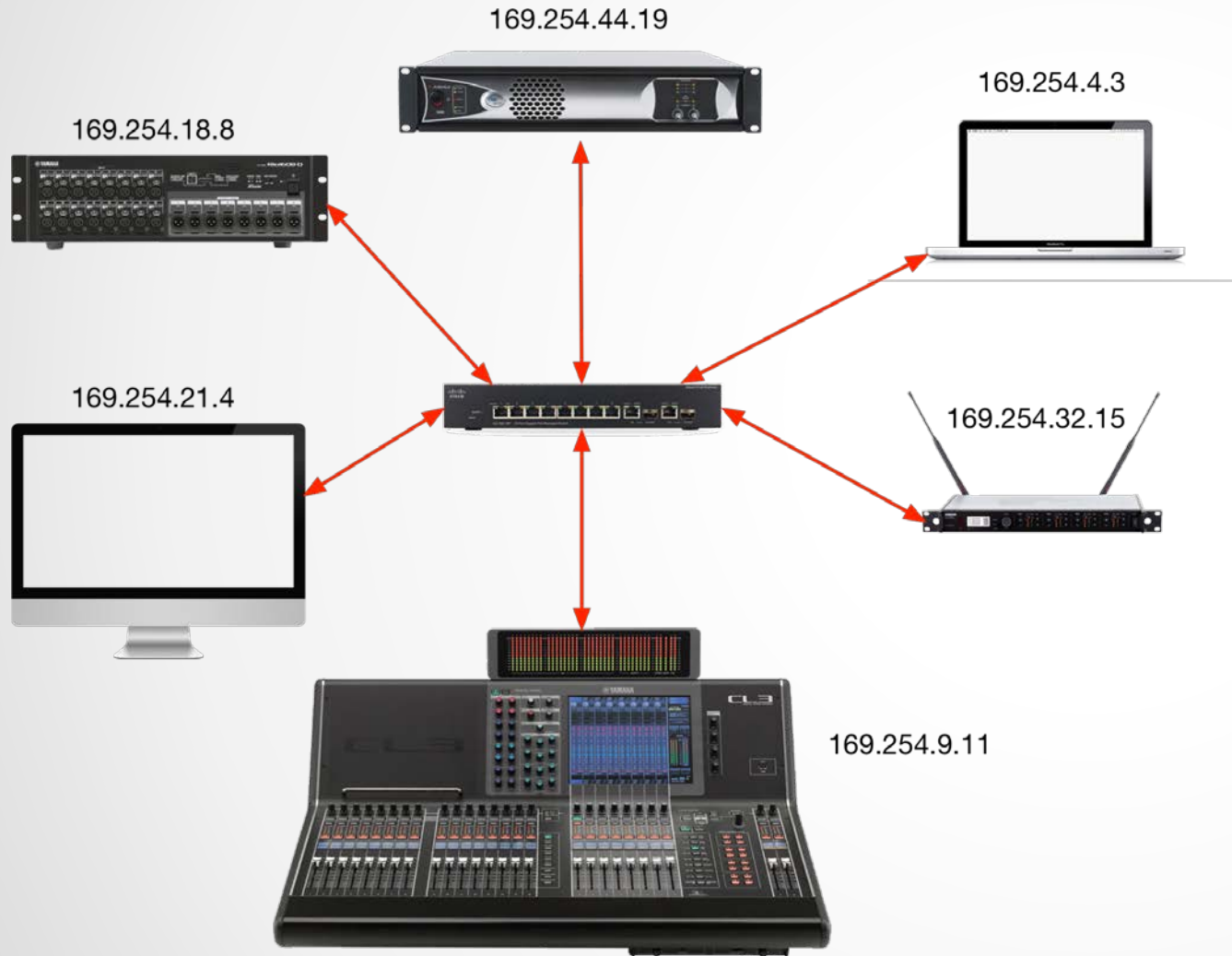

LAN requires IP addresses in a common range

- Automatic addressing enabled by default on Dante devices

- Self-assigned addresses create a working LAN

SUMMARY

Layer 3 networking allows use of IP addresses for connections

Automatic addressing enables simple “plug and play” use of Dante in stand alone networks – use it!

“Stand alone” networks are commonly used to separate and simplify responsibilities

WHAT IS DANTE?

DANTE CERTIFICATION PROGRAM
LEVEL 1



DANTE IS A HARDWARE AND
SOFTWARE SOLUTION THAT
TRANSPORTS PRECISELY
TIMED DIGITAL AUDIO
BETWEEN DEVICES USING
STANDARD IP NETWORKING

DANTE FEATURES AND BENEFITS

All devices use human-readable names



Precise time alignment of all audio



Automatic device discovery



One-click routing

Low, deterministic latency



Virtually jitter-free



Automatic re-connection after power cycles

HOW IS DANTE BUILT INTO PRODUCTS?

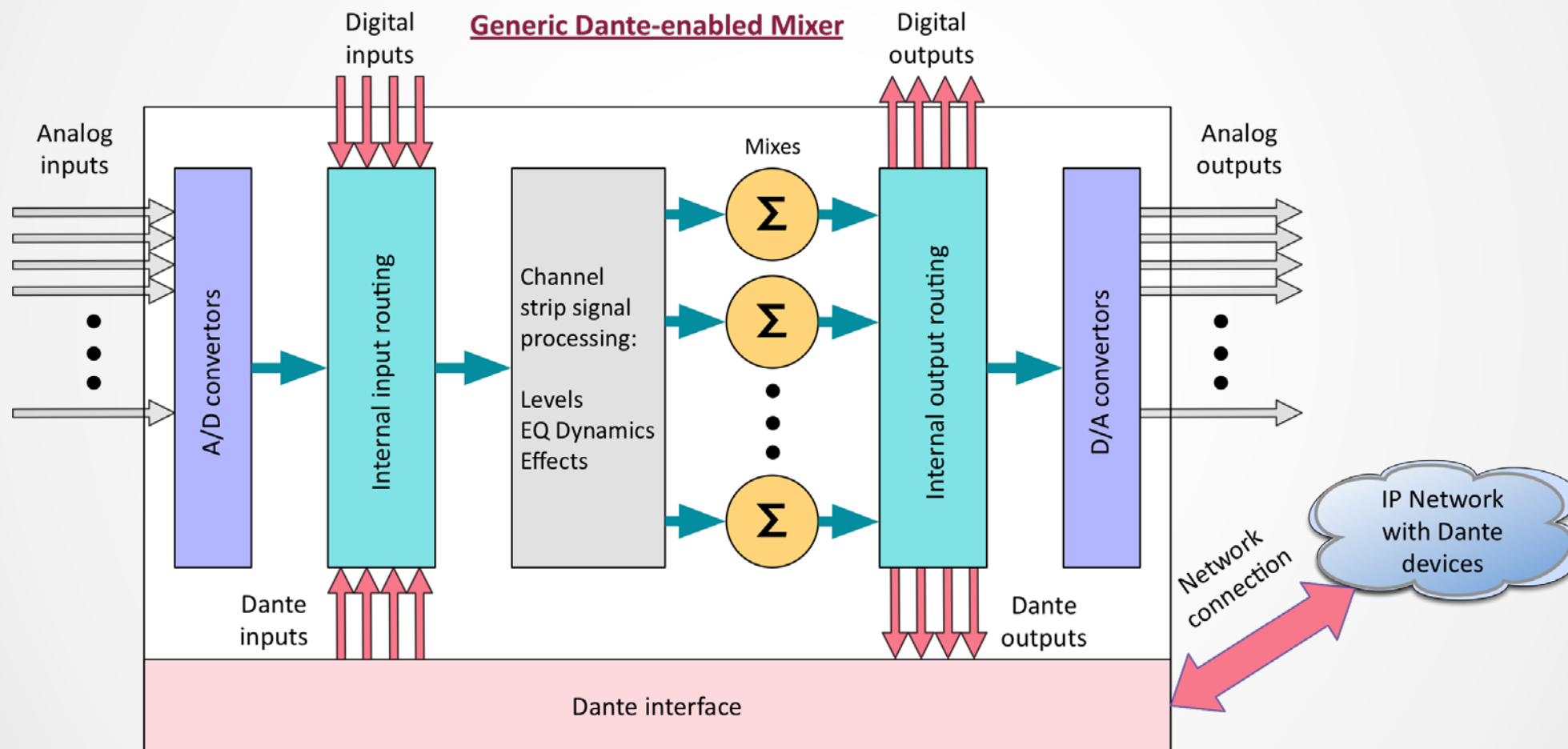

DANTE BANDWIDTH

Legacy digital systems constrained to lower channel count

- Gigabit means Dante is capable of 512x512 at each link, many more for entire network

- Even a large 64 channel console consumes only 1/8 capacity of a single port

Max Channels per link

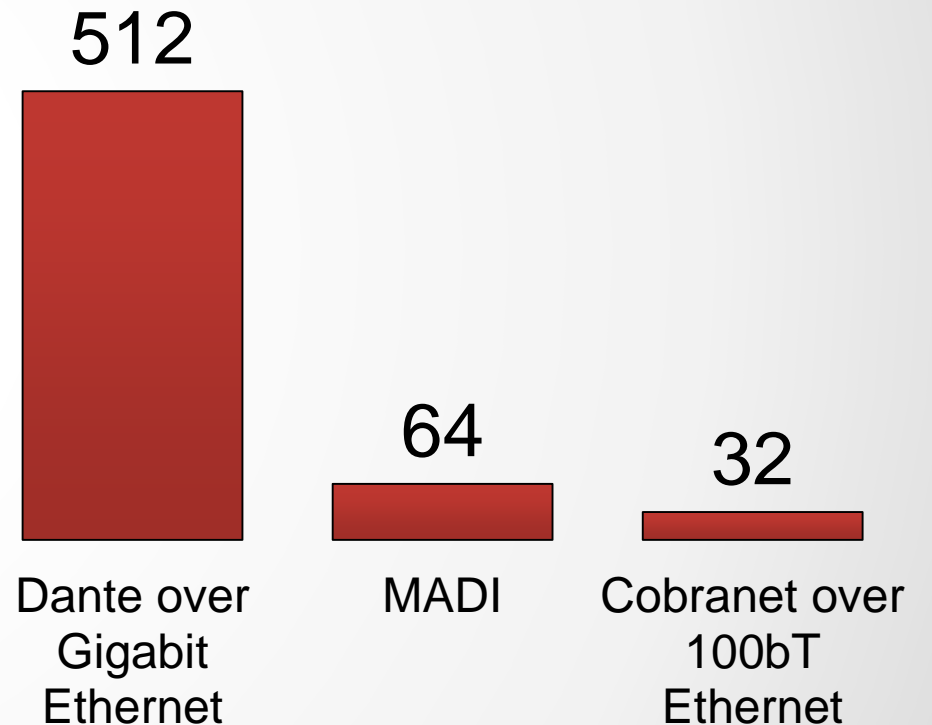

SAMPLE RATE AND CONNECTION



Only Dante channels using the same sample rate may connect

- Multiple sample rates on the same network OK

- Higher sample rates = fewer channels for same bandwidth

- All common sample rates supported

LATENCY

- 100% deterministic – always well-defined
- Default Dante latency 1ms – suitable for large networks (10 hops!)
- Adjustable to suit needs
 - Minimum 150µs
 - Maximum 5ms
- Set per Device

Device Latency

Current latency: 1 msec

	Latency	Maximum Network Size
<input type="radio"/>	150 usec	Gigabit network with one switch
<input type="radio"/>	250 usec	Gigabit network with three switches
<input type="radio"/>	500 usec	Gigabit network with five switches
<input checked="" type="radio"/>	1 msec	Gigabit network with ten switches or gigabit network with 100Mbps leaf nodes
<input type="radio"/>	2 msec	Gigabit network with 100Mbps leaf nodes
<input type="radio"/>	5 msec	Safe value

CLOCKING

Dante handles clocking automatically



Clock Master is determined by election



All devices sync'd to Master



Each device has a clock



New Clock Master elected as needed

**CLOCK
MASTER**

A conductor in a white jacket is seen from behind, leading an orchestra. The words "CLOCK MASTER" are printed on the back of his jacket. The conductor is holding a baton in his right hand. The orchestra members are seated in front of him, playing various instruments. The background is a warm, reddish-brown color.

WHAT DOES DANTE NOT DO?

Sample rate conversion



Level control



MIDI



SMPTE time code

These are handled by products
Control and other data runs alongside Dante
on network



USING DANTE

DANTE CERTIFICATION PROGRAM
LEVEL 1

DANTE CONTROLLER

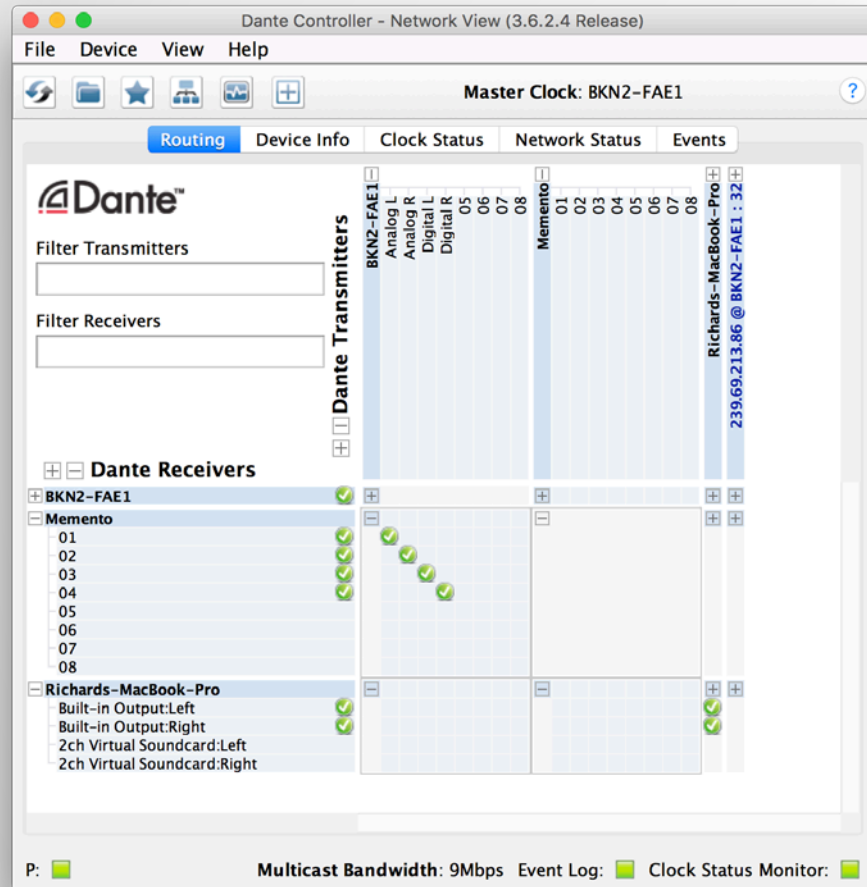

Primary Dante tool

•
Routing: Setup, view, change

•
Clocking adjustments

•
Sample Rate settings

•
Latency settings

•
Clock and Latency monitoring

DISCOVERY AND ROUTING

If no devices are connected, Dante Controller is empty

Dante Controller always shows the *current state of the network*

Key concept: Dante configuration lives in *devices*, not on your computer

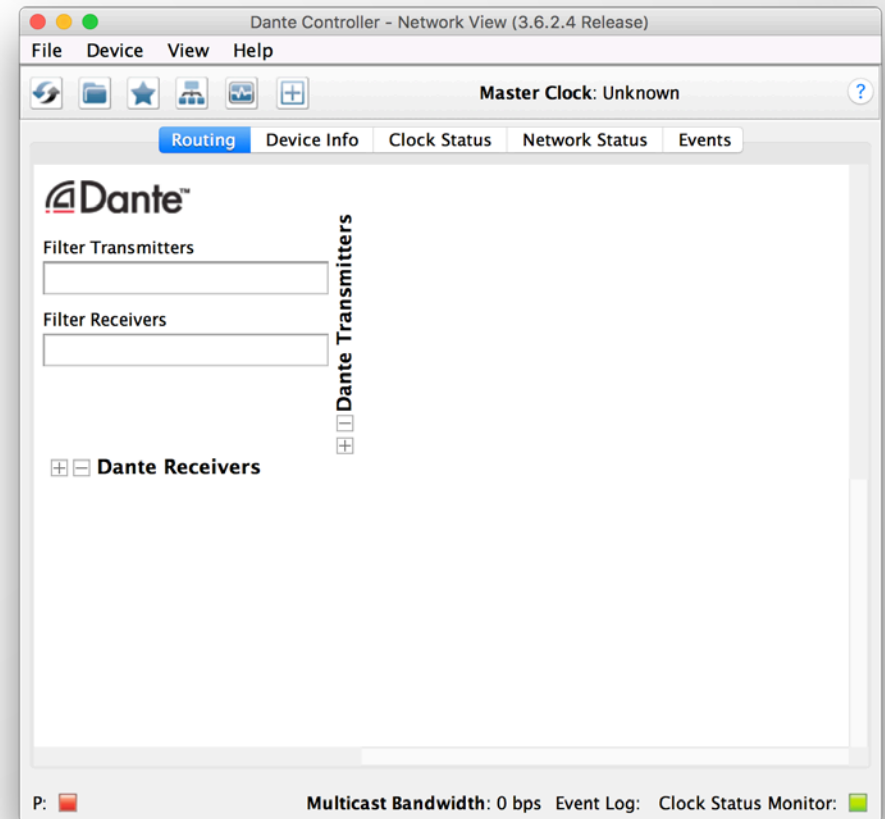

DISCOVERY AND ROUTING

DIRECTLY CONNECT ONE DEVICE

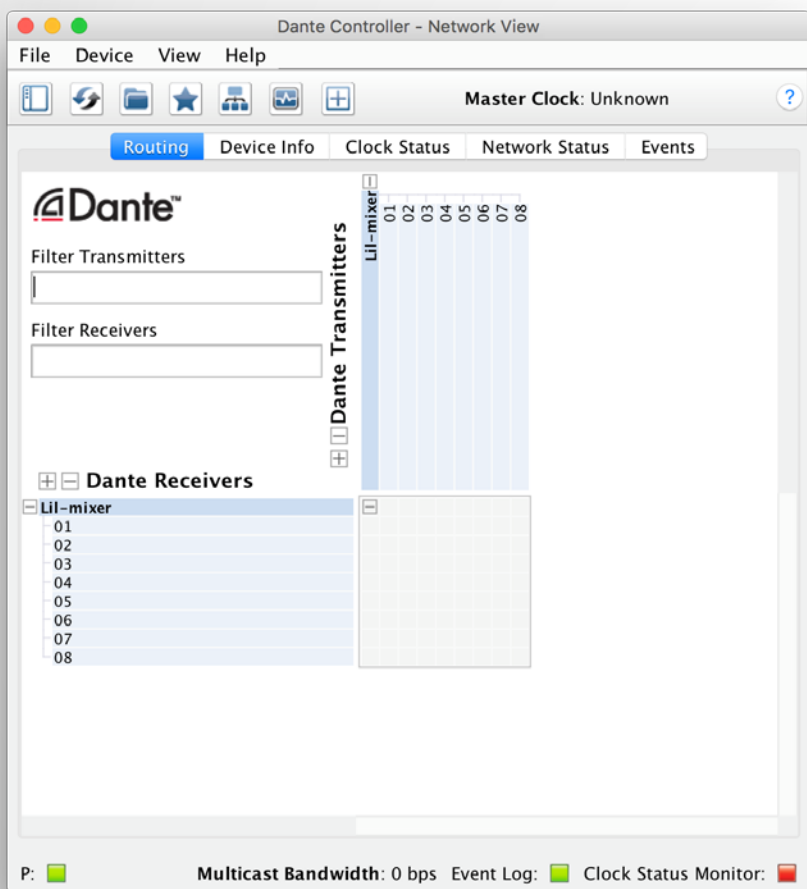

When they are connected to network,
Dante devices automatically appear in
Dante Controller

- No pre-configuration

- Human readable names

- *A Dante device can be connected directly to a computer*

DISCOVERY AND ROUTING

MULTIPLE DEVICES AND CHANNELS

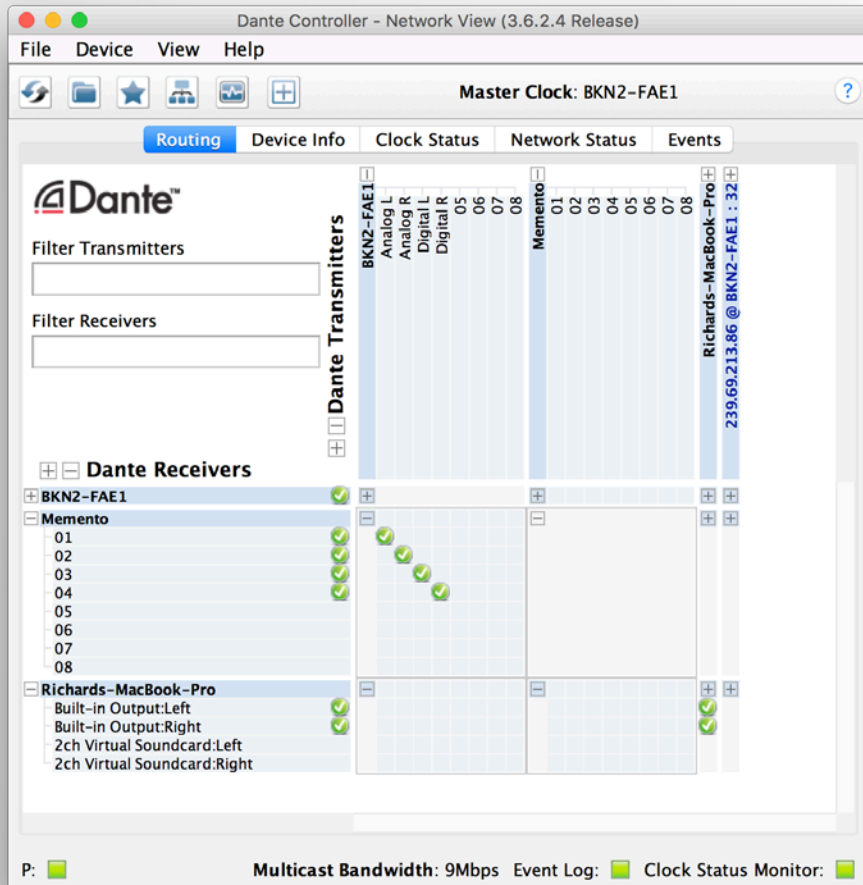

Use switch to connect multiple devices

Click “+” sign to view device channels
Click “-” sign to hide channels

Transmitter channels on horizontal

Receiver channels on vertical

DISCOVERY AND ROUTING SUBSCRIPTIONS



- Dante connections are “subscriptions”
- With device channels showing, click at intersection of desired transmit and receive channels
- Green checkmark means subscription is OK
- Sample rates and types match

DISCOVERY AND ROUTING

DELETING



To delete a subscription, click on green checkmark

•
Checkmark disappears,
subscription deleted

DISCOVERY AND ROUTING SPLITS

Splits are easy with Dante

- Simply click at intersections of multiple receiver's channels for a desired transmitter

- Audio is sent to all subscribed devices and channels

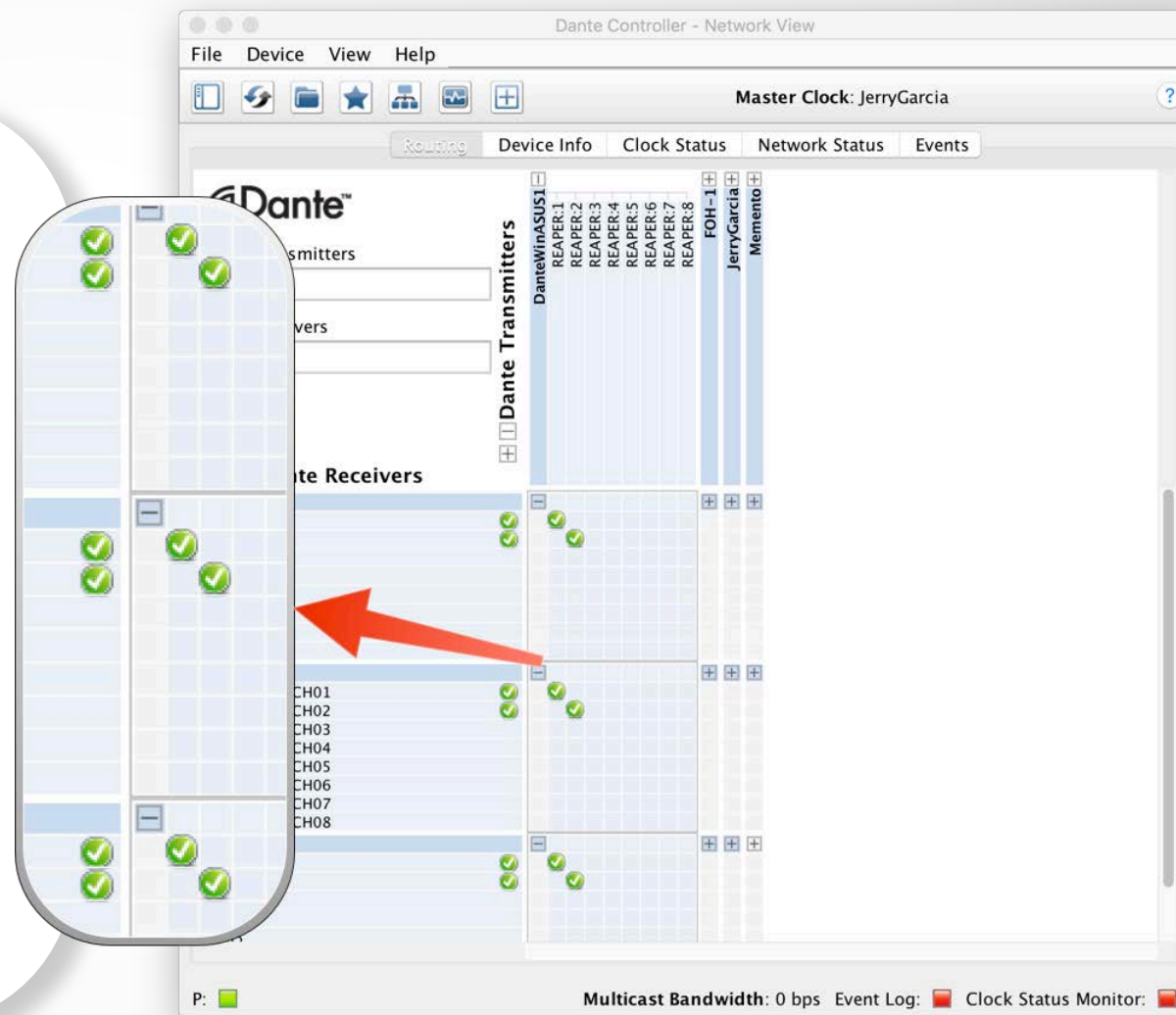

DEVICE NAMES

Recommended: Name first, then route

You can use device names of your choice

Double click device in Routing view, go to Device Config tab

Edit name

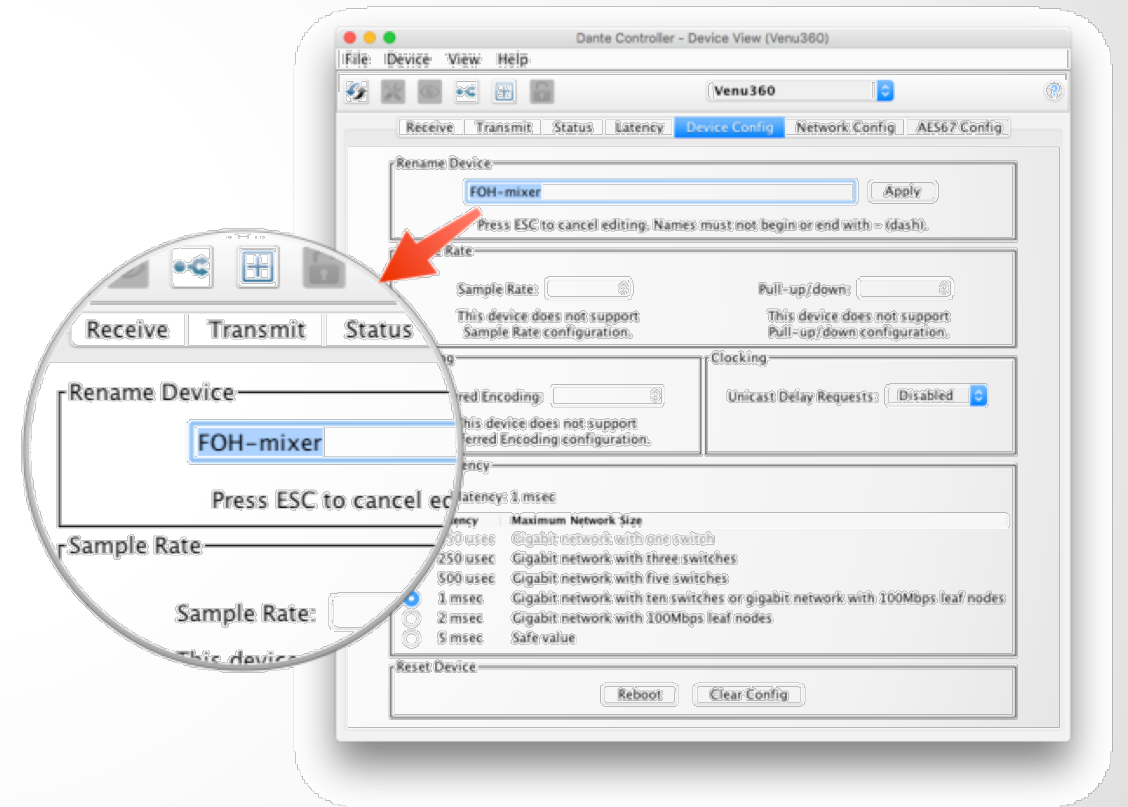

CHANNEL LABELS

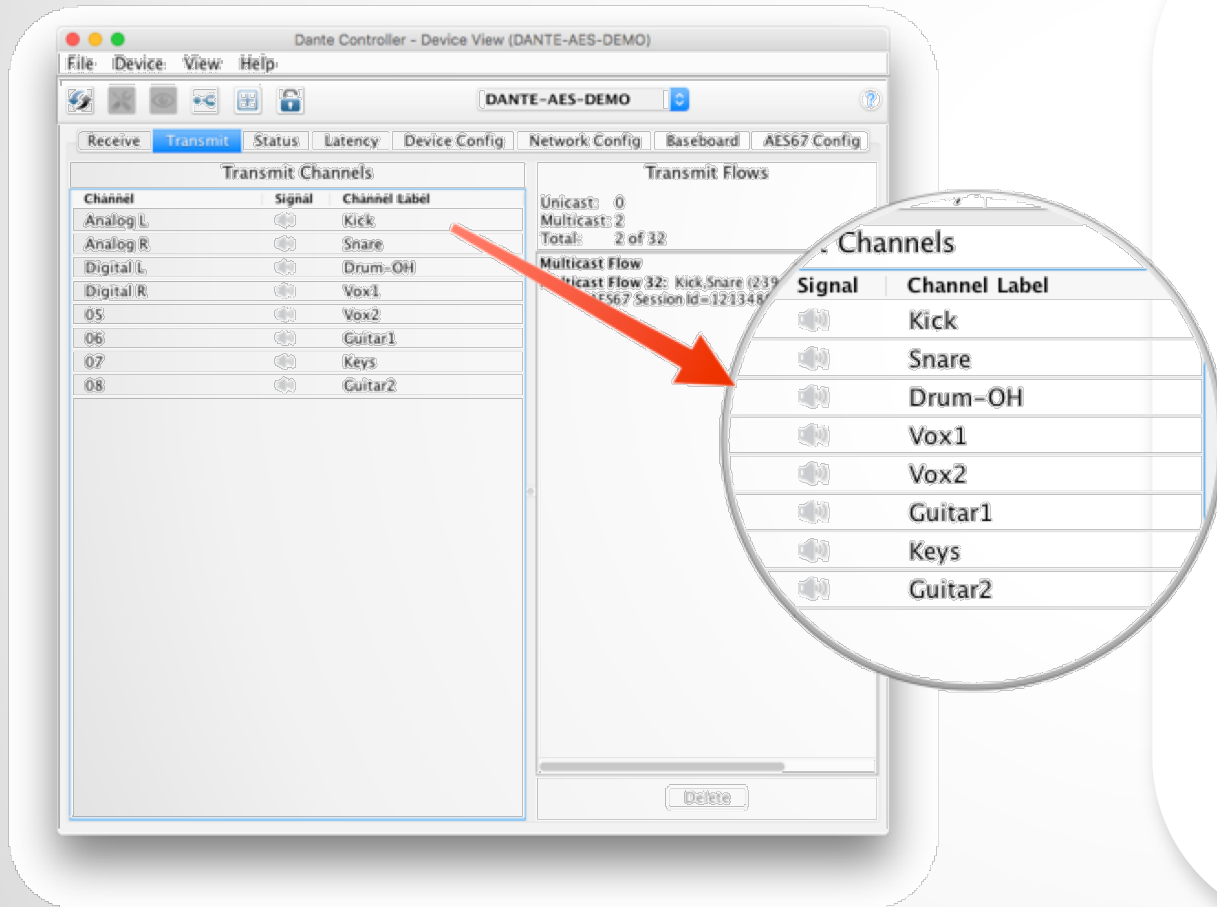

Labels can be applied to any channels

- Use Device View

- Makes it easy for volunteers or newbies to use system

- Software version of masking tape 😊

ADJUST SAMPLE RATE

In Device View -> Device Config tab

- Adjust sample rate and bit depth (Encoding)

- Choices determined by product

- Most common 48kHz / PCM 24

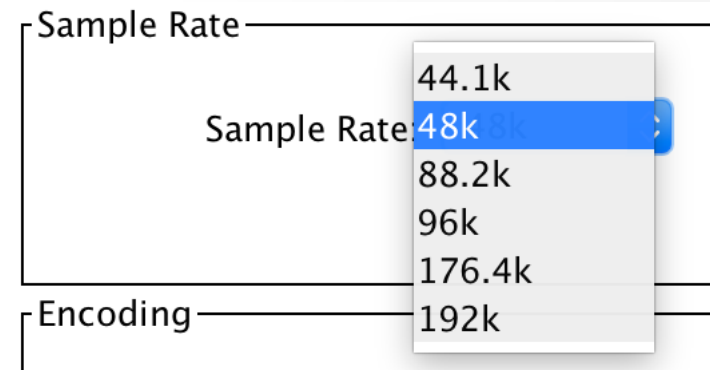

POWER CYCLE RECOVERY

Configurations are stored in Dante devices – not in Dante Controller

- At power up and/or reconnection, all subscriptions are re-established

- Dante Controller not required!





NO

DOES DANTE CONTROLLER NEED TO BE
ON THE NETWORK ALL THE TIME?

SUMMARY: KEY TAKEAWAYS 1

Dante Controller automatically displays connected devices



Dante devices and channels have user-definable names



Dante Controller displays both transmitter (source) and receiver (sink) channels



Channel to channel connections are called **subscriptions**



Subscriptions are made and deleted by clicking at the intersection of transmit and receive channels

SUMMARY: KEY TAKEAWAYS 2

Subscriptions may only be made between devices running the same sample rate, adjusted in Device View



Dante devices “remember” settings and subscriptions



Dante automatically selects a Master Clock



Dante Controller does not need to remain on network



Dante does not alter audio data in any way



RECORDING WITH DANTE VIRTUAL SOUNDCARD

DANTE CERTIFICATION PROGRAM
LEVEL 1

WHAT IS DANTE VIRTUAL SOUND CARD? (DVS)

Soft Soundcard for Mac or PC

- Connects to Dante network

- Record and playout from 2x2 up to 64x64 channels using any DAW software

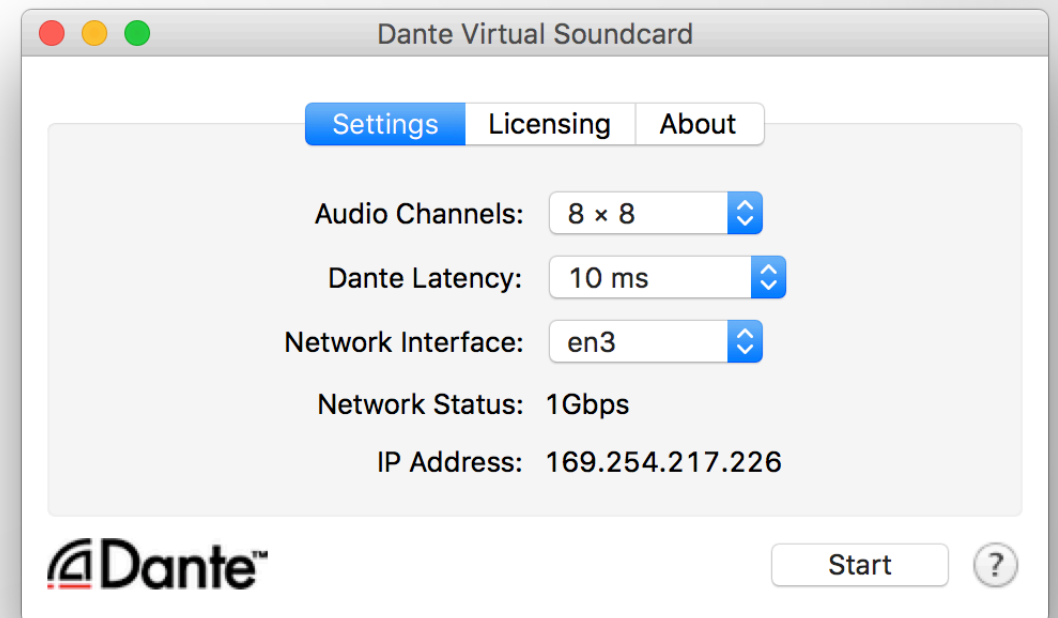

CONNECT TO A DAW

Launch Dante Virtual Soundcard

•
Set number of channels and Start DVS

•
DVS will appear as audio device on computer

Mac – Core Audio

Windows – ASIO or WDM

•
Select as I/O device in DAW preferences

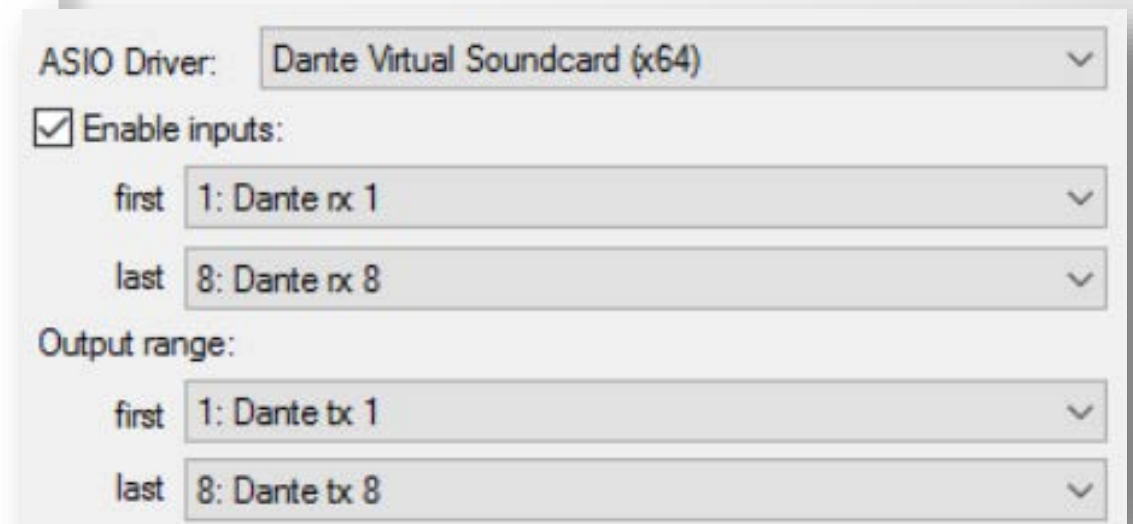

SUBSCRIBE CHANNELS

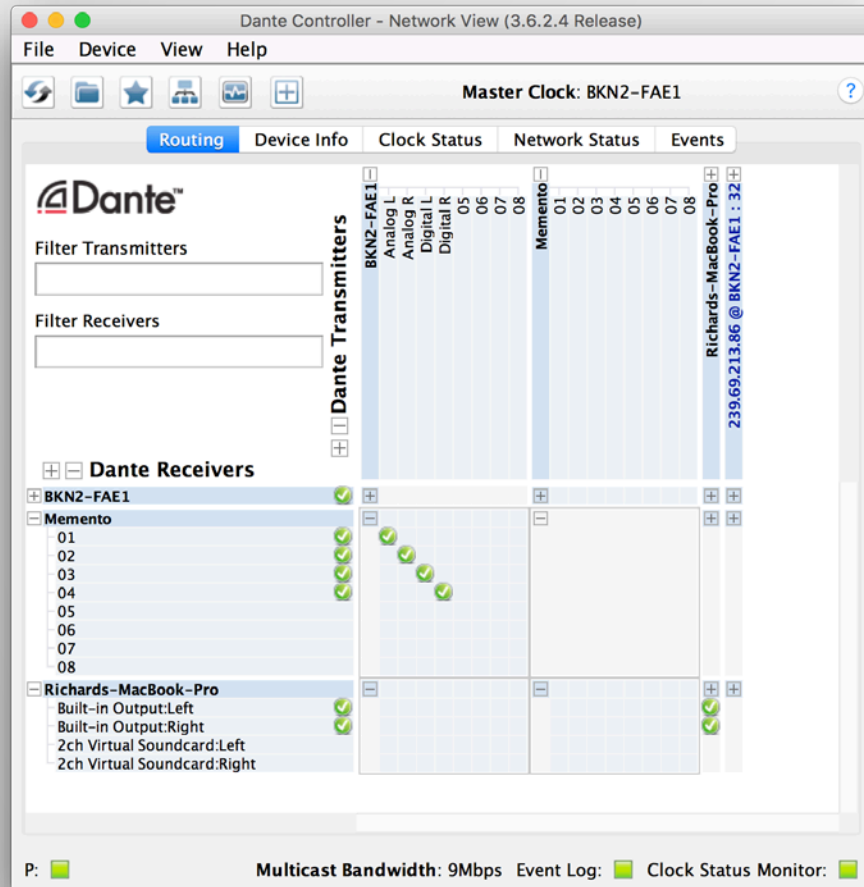

Open Dante Controller

•
Computer with DVS appears as Dante device

•
Subscribe channels to Dante devices on network

•
Record and Playout with DAW

NOW WHAT?

NEXT STEPS

- Want to know more?
- Take Level 2!
- Go in depth on:
 - Dante Controller
 - Dante Virtual Soundcard
 - Using Multicast
 - Redundant Dante networks
 - More!



TAKE THE TEST

<http://www.audinate.com/certify>

- Create Audinate account if you don't have one
- Login at URL
- Take Level 1 test
- Certificate automatically generated

THANK
YOU